

Instruction Manual

HI 96101C

pH, Chlorine, Cyanuric Acid, Iodine, Bromine, Iron LR ISM

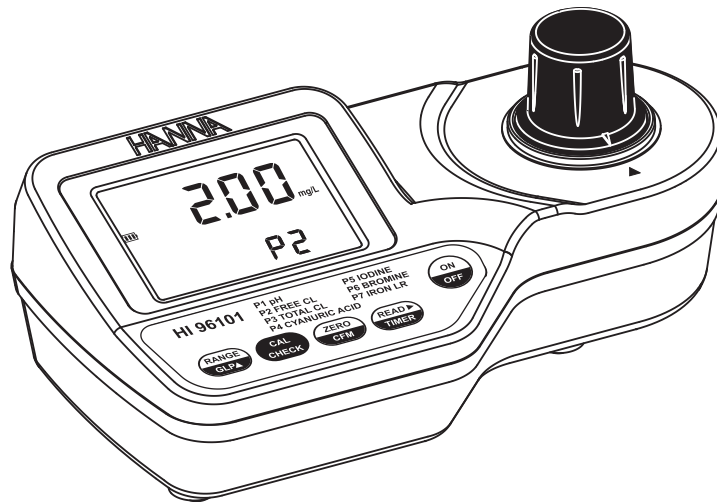

Dear Customer,

Thank you for choosing a Hanna product. This manual will provide you with the necessary information for the correct use of the instrument. Please read it carefully before using the meter. If you need additional technical information, do not hesitate to e-mail us at tech@hannainst.com.

TABLE OF CONTENTS

PRELIMINARY EXAMINATION	3
GENERAL DESCRIPTION	4
ABBREVIATIONS	5
SPECIFICATIONS	5
PRECISION AND ACCURACY	7
PRINCIPLE OF OPERATION	8
FUNCTIONAL DESCRIPTION	10
ERRORS AND WARNINGS	12
GENERAL TIPS FOR AN ACCURATE MEASUREMENT	14
STARTUP	15
RANGE SELECTION	16
MEASUREMENT PROCEDURE	16
VALIDATION PROCEDURE	28
CALIBRATION PROCEDURE	29
GLP	32
BATTERY MANAGEMENT	33
BATTERY REPLACEMENT	33
ACCESSORIES	34
WARRANTY	35

PRELIMINARY EXAMINATION

Please examine this product carefully. Make sure that the instrument is not damaged. If any damage occurred during shipment, please notify your Dealer.

Each HI 96101 Ion Selective Meter is supplied complete with:

- Two Sample Cuvettes and Caps
- Seven CAL CHECK standard cuvettes HI 96101KIT
- 9V Battery
- Tissue for wiping cuvettes
- Instrument quality certificate
- Instruction Manual
- Rigid carrying case

CAL CHECK Standard Cuvettes
HI 96101KIT

Cut-out space for reagent
powder packets HI 93701-0 &
HI 93711-0 & HI93722-0

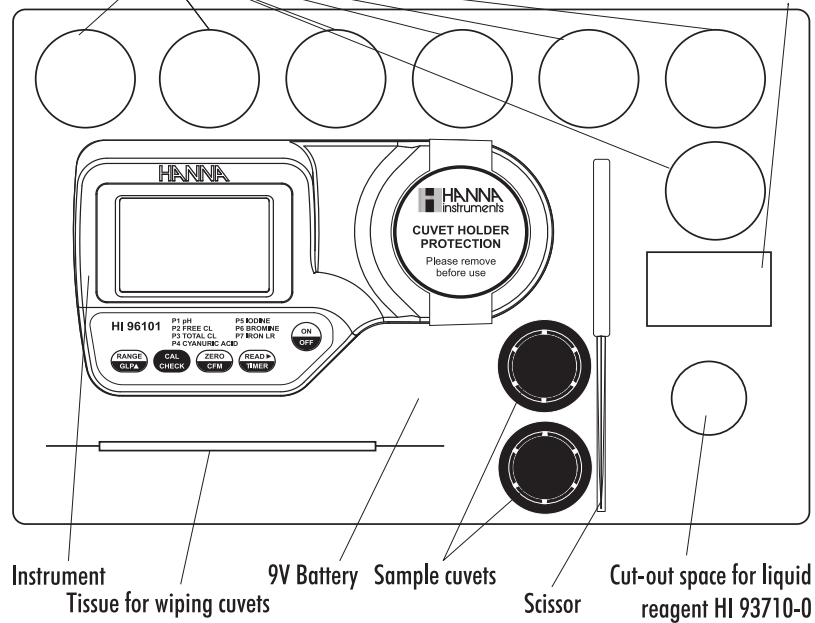

Note: Save all packing material until you are sure that the instrument works correctly. Any defective item must be returned in its original packing.

GENERAL DESCRIPTION

The **HI 96101** is an auto diagnostic portable microprocessor meter that benefits from Hanna's years of experience as a manufacturer of analytical instruments. It has the advanced optical system based on a special tungsten lamp and a narrow band interference filter that allows most accurate and repeatable readings. All instruments are factory calibrated and the electronic and optical design minimizes the need of frequent calibration.

With the powerful **CAL CHECK™ validation** function, you are able to validate good performance of your instrument at any time. The validation procedure is extremely user friendly. Just use the exclusive HANNA ready-made, NIST traceable standards to verify the performance of the instrument and recalibrate if necessary.

All instruments are splash waterproof and the lamp and filter units are protected from dust or dirt by a transparent cup. This makes the instruments fulfill field applications. Display messages aid the user in routine operation. The meter has an auto-shut off feature that will turn off the instrument after 10 minutes of non use in *measurement mode* or after 1 hour if left in *calibration mode*.

The meter uses an exclusive positive-locking system to ensure that the cuvette is in the same position every time it is placed into the measurement cell. It is designed to fit a cuvette with a larger neck making it easier to add both sample and reagents. The cuvette is made from special optical glass to obtain best results.

The **HI 96101** meter measures pH, Free and Total Chlorine, Cyanuric Acid, Iodine, Bromine and Iron Low Range content in water and wastewater samples in the following ranges:

Parameter	Range
pH	6.5 to 8.5 pH
Free Chlorine	0.00 to 5.00 mg/L
Total Chlorine	0.00 to 5.00 mg/L
Cyanuric Acid	0 to 80 mg/L
Iodine	0.0 to 12.5 mg/L
Bromine	0.00 to 10.00 mg/L
Iron LR	0.00 to 1.60 mg/L

The reagents are in liquid and powder form depending on the parameter and they are supplied in dropper bottles and packets. The amount of reagent is precisely dosed to ensure the maximum repeatability.

ABBREVIATIONS

°C: degree Celsius
 °F: degree Fahrenheit
 mg/L: milligrams per liter. mg/L is equivalent to ppm (parts per million)
 mL: milliliter
 mV: millivolts
 USEPA: US Environmental Protection Agency

SPECIFICATIONS

Range	pH	6.5 to 8.5 pH
	Free Chlorine	0.00 to 5.00 mg/L
	Total Chlorine	0.00 to 5.00 mg/L
	Cyanuric Acid	0 to 80 mg/L
	Iodine	0.0 to 12.5 mg/L
	Bromine	0.00 to 10.00 mg/L
	Iron LR	0.00 to 1.60 mg/L
	Resolution	0.1 pH
0.01 mg/L under 3.50 mg/L Chlorine		
0.10 mg/L above 3.50 mg/L Chlorine		
1 mg/L Cyanuric Acid		
0.1 mg/L Iodine		
0.01 mg/L Bromine		
Accuracy	0.01 mg/L Iron LR	
	pH	±0.1 pH @ 25°C
	Free Chlorine	±0.03 ±3% of reading @ 25°C
	Total Chlorine	±0.03 ±3% of reading @ 25°C
	Cyanuric Acid	±1 mg/L ±15% of reading @ 25°C
	Iodine	±0.1 mg/L ±5% of reading @ 25°C
	Bromine	±0.08 mg/L ±3% of reading @ 25°C
Iron LR	±0.01 mg/L ±8% of reading @ 25°C	
Typical EMC Deviation	±0.1 pH	
	±0.01 mg/L Bromine, Chlorine	
	±1 mg/L Cyanuric Acid	
	±0.1 mg/L Iodine	
	±0.02 mg/L Iron LR	

Light Source	Tungsten lamp
Light Detector	Silicon Photocell with narrow band interference filter @ 525 nm
Methods	<p>For pH: Phenol red method. The reaction with reagents causes a red tint in the sample.</p> <p>For Chlorine: Adaptation of the USEPA method and Standard Method 4500-Cl G. The reaction with reagents causes a pink tint in the sample.</p> <p>For Cyanuric Acid: Adaptation of the turbidimetric method. The reaction between cyanuric acid and the reagent causes a white suspension in the sample.</p> <p>For Iodine: Adaptation of the EPA, DPD method. The reaction between iodine and the reagent causes a pink tint in the sample.</p> <p>For Bromine: Adaptation of the EPA, DPD method. The reaction between bromine and the reagent causes a pink tint in the sample.</p> <p>For Iron LR: Adaptation of the TPTZ method. The reaction between iron and the reagent causes a violet tint in the sample.</p>
Environment	0 to 50°C (32 to 122°F); max 95% RH non-condensing
Battery Type	1 x 9 volt
Auto-Shut off	After 10' of non-use in <i>measurement mode</i> ; after 1 hour of non-use in <i>calibration mode</i> ; with last reading reminder.
Dimensions	192 x 104 x 69 mm (7.6 x 4.1 x 2.7")
Weight	360 g (12.7 oz.).

REQUIRED REAGENTS

<u>Code</u>	<u>Parameter</u>	<u>Description</u>	<u>Quantity/test</u>
HI 93710-0	pH	Phenol red	5 drops
HI 93701-0	Free Chlorine	DPD Powder Reagent	1 packet
HI 93711-0	Total Chlorine	DPD Powder Reagent	1 packet
HI 93722-0	Cyanuric Acid	Powder Reagent	1 packet
HI 93718-0	Iodine	DPD Powder Reagent	1 packet
HI 93716-0	Bromine	DPD Powder Reagent	1 packet
HI 93746-0	Iron LR	Powder Reagent	2 packet

PRECISION AND ACCURACY

Precision is how closely repeated measurements agree with each other. Precision is usually expressed as standard deviation (SD).

Accuracy is defined as the nearness of a test result to the true value.

Although good precision suggests good accuracy, precise results can be inaccurate. The figure explains these definitions.

In a laboratory using a standard solution of the parameter and a representative lot of reagent (for each parameter) the following standard deviations were obtained:

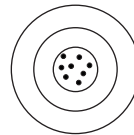

Precise, accurate

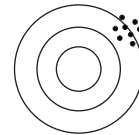

Precise, not accurate

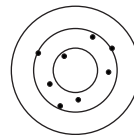

Accurate, not precise

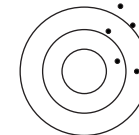

Not precise, not accurate

Parameter	Standard Solution	Standard Deviation
pH	7.0 pH	0.1 pH units
Free Chlorine	1.00 mg/L	0.03 mg/L
Total Chlorine	1.00 mg/L	0.03 mg/L
Cyanuric Acid	20 mg/L	1 mg/L
Iodine	2.5 mg/L	0.1 mg/L
Bromine	2.00 mg/L	0.08 mg/L
Iron LR	0.80 mg/L	0.01 mg/L

PRINCIPLE OF OPERATION

Absorption of Light is a typical phenomenon of interaction between electromagnetic radiation and matter. When a light beam crosses a substance, some of the radiation may be absorbed by atoms, molecules or crystal lattices.

If pure absorption occurs, the fraction of light absorbed depends both on the optical path length through the matter and on the physical-chemical characteristics of the substance according to the Lambert-Beer Law:

$$-\log \frac{I}{I_0} = \epsilon_{\lambda} c d$$

or

$$A = \epsilon_{\lambda} c d$$

Where:

- log I/I_0 = Absorbance (A)
- I_0 = intensity of incident light beam
- I = intensity of light beam after absorption
- ϵ_{λ} = molar extinction coefficient at wavelength λ
- c = molar concentration of the substance
- d = optical path through the substance

Therefore, the concentration "c" can be calculated from the absorbance of the substance as the other factors are known.

Photometric chemical analysis is based on the possibility to develop an absorbing compound from a specific chemical reaction between sample and reagents. Given that the absorption of a compound strictly depends on the wavelength of the incident light beam, a narrow spectral bandwidth should be selected as well as a proper central wavelength to optimize measurements. The optical system of Hanna's **HI 96** series colorimeters is based on special subminiature tungsten lamps and narrow-band interference filters to guarantee both high performance and reliable results.

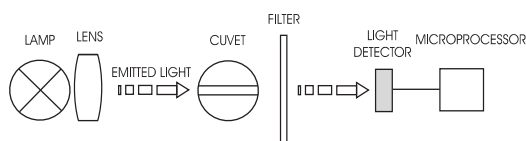

HI 96 block diagram (optical layout)

A microprocessor controlled special tungsten lamp emits radiation which is first optically conditioned and beamed to the sample contained in the cuvette. The optical path is fixed by the diameter of the cuvette. Then the light is spectrally filtered to a narrow spectral bandwidth, to obtain a light beam of intensity I_0 or I .

The photoelectric cell collects the radiation \mathcal{I} that is not absorbed by the sample and converts it into an electric current, producing a potential in the mV range.

The microprocessor uses this potential to convert the incoming value into the desired measuring unit and to display it on the LCD.

The measurement process is carried out in two phases: first the meter is zeroed and then the actual measurement is performed.

The cuvette has a very important role because it is an optical element and thus requires particular attention. It is important that both, the measurement and the calibration (zeroing) cuvettes, are optically identical to provide the same measurement conditions. Whenever possible use the same cuvette for both. It is necessary that the surface of the cuvette is clean and not scratched. This to avoid measurement interference due to unwanted reflection and absorption of light. It is recommended not to touch the cuvette walls with hands.

Furthermore, in order to maintain the same conditions during the zeroing and the measuring phases, it is necessary to close the cuvette to prevent any contamination.

FUNCTIONAL DESCRIPTION

INSTRUMENT DESCRIPTION

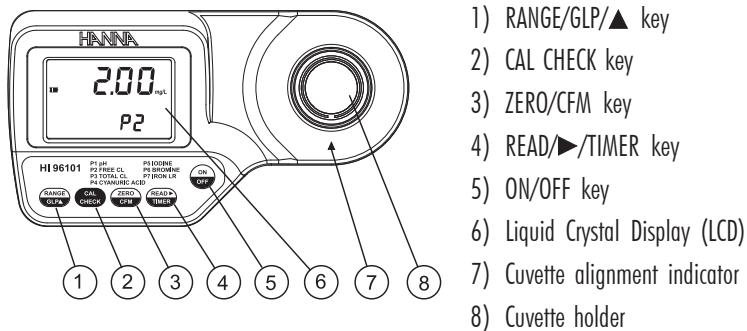

KEYPAD DESCRIPTION

- **ON/OFF**: to turn the meter on and off.
- **ZERO/CFM**: this is a bi-functional key. Just press to zero the meter prior to measurement, or confirm edited values. In *calibration mode* press to confirm factory calibration restore.
- **READ/▶/TIMER**: this is a multi-functional key. In *measurement mode*, press to make a measurement, or press and hold for three seconds to start a pre-programmed countdown prior to measurement. In *GLP mode* press to view the next screen.
- **CAL CHECK**: this is a bi-functional key. Just press to perform the validation of the meter, or press and hold for three seconds to enter *calibration mode*.
- **RANGE/GLP/▲**: this is a multi-functional key. In *measurement mode*, press to change the parameter. Press and hold for three seconds to enter *GLP mode*. In *calibration mode* press to edit the date and time.

OPERATING MODES

- *Measurement mode*: default operation mode, enables both **validation** and **measurement**.
- *Calibration mode*: may be entered by keeping **CAL CHECK** pressed for three seconds (the "CAL" tag appears), it enables **calibration** of the instrument.
- *GLP mode* may be entered by pressing **RANGE/GLP/▲** ("GLP" appears), it enables consulting of user calibration date or restore factory calibration.

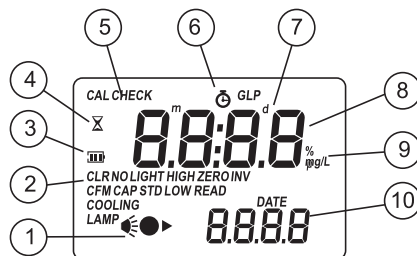

DISPLAY ELEMENTS DESCRIPTION

- 1) The measuring scheme (lamp, cuvette, detector), appears during different phases of zero or reading measurement
- 2) Error messages and warnings
- 3) The battery icon indicates the charge state of the battery
- 4) The hourglass appears when an internal check is in progress
- 5) Status messages
- 6) The chronometer appears when the reaction timer is running
- 7) The month, day and date icons appear when a date is displayed
- 8) Four digit main display
- 9) Measuring units
- 10) Four digit secondary display

ERRORS AND WARNINGS

The instrument shows clear messages when erroneous condition appears. Messages are also displayed when the obtained values are outside expected range. The beeper is playing a beep on errors.

a) on zero reading

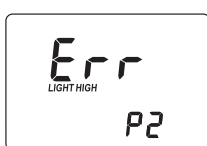

Light High: There is too much light to perform a measurement. Please check the preparation of the zero cuvette.

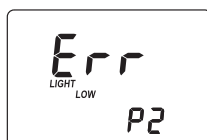

Light Low: There is not enough light to perform a measurement. Please check the preparation of the zero cuvette.

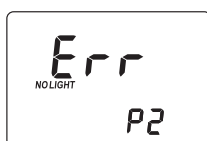

No Light: The instrument cannot adjust the light level. Please check that the sample does not contain any debris.

b) on sample reading

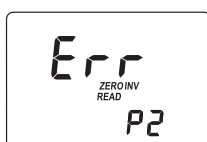

Inverted cuvettes: The sample and the zero cuvette are inverted.

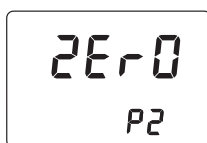

Zero: A zero reading was not taken. Follow the instructions of the measurement procedure for zeroing the meter.

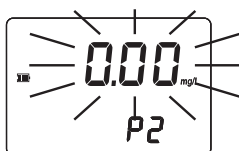

Under Range: A blinking "0.00" indicates that the sample absorbs less light than the zero reference. Check the procedure and make sure you use the same cuvette for reference (zero) and measurement.

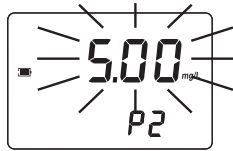

Over Range: A flashing value of the maximum concentration indicates an over range condition. The concentration of the sample is beyond the programmed range: dilute the sample and re-run the test.

c) during calibration procedure

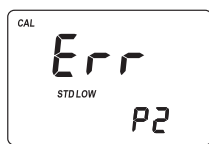

Standard Low: The standard reading is less than expected.

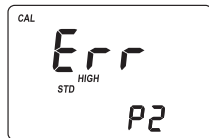

Standard High: The standard reading is higher than expected.

d) other errors and warnings

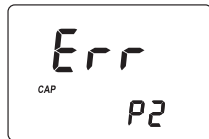

Cap error: Appears when external light enters in the analysis cell. Assure that the cuvette cap is present.

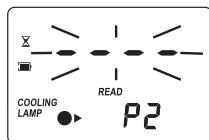

Cooling lamp: The instrument waits for the lamp to cool down.

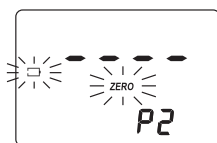

Battery low: The battery must be replaced soon.



Dead battery: This indicates that the battery is dead and must be replaced. Once this indication is displayed, normal operation of the instrument will be interrupted. Change the battery and restart the meter.

GENERAL TIPS FOR AN ACCURATE MEASUREMENT

The instructions listed below should be carefully followed during testing to ensure best accuracy.

- Color or suspended matter in large amounts may cause interference, therefore these should be removed by treatment with active carbon and by prior filtration.
- For a correct filling of the cuvette: the liquid in the cuvette forms a concavity on the top; the bottom of this concavity must be at the same level of the 10 mL mark.
- Proper use of the powder reagent packet:
 - (a) use scissors to open the powder packet;
 - (b) push the edges of the packet to form a spout;
 - (c) pour out the content of the packet.

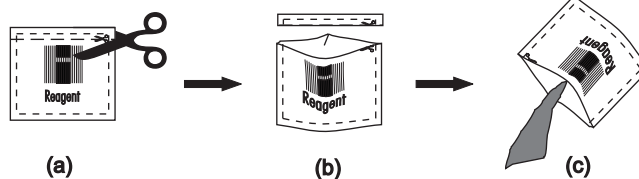

- Proper use of dropper:
 - (a) to get good reproducible results, tap the dropper on the table for several times and wipe the outside of the dropper with a cloth.
 - (b) always keep the dropper bottle in a vertical position while dosing the reagent.

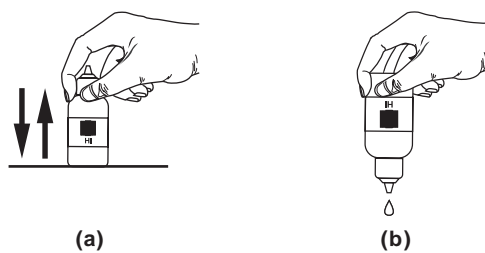

- It is important that the sample does not contain any debris. This would corrupt the reading.
- Each time the cuvette is used, the cap must be tightened to the same degree.
- Whenever the cuvette is placed into the measurement cell, it must be dry outside, and completely free of fingerprints, oil or dirt. Wipe it thoroughly with **HI 731318** or a lint-free cloth prior to insertion.
- Shaking the cuvette can generate bubbles in the sample, causing higher readings. To obtain accurate measurements, remove such bubbles by swirling or by gently tapping the cuvette.
- Do not let the reacted sample stand too long after reagent is added, or accuracy will be lost.
- It is possible to take multiple readings in a row, but it is recommended to take a new zero reading for each sample and to use the same cuvette for zeroing and measurement.
- After the reading it is important to discard immediately the sample, otherwise the glass might become permanently stained.
- All the reaction times reported in this manual are referred to 20°C (68°F). As a general rule of thumb, they should be doubled at 10°C (50°F) and halved at 30°C (86°F).
- In order to maximize accuracy, prior to a measurement follow the **validation procedure** to be sure that the instrument is properly calibrated. If necessary, calibrate the instrument.

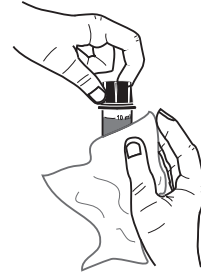

STARTUP

Prepare the instrument for measurement as follows:

- Unpack the instrument by removing the dust protection sleeve from the instrument cuvette holder.
- Place the battery in the instrument as described in the "BATTERY REPLACEMENT" chapter.
- Place the instrument on a flat table.
- Do not place the instrument under direct sun light.

RANGE SELECTION

The HI 96101 can measure pH when range P1 is selected, Free Chlorine when range P2 is selected, Total Chlorine when range P3, Cyanuric Acid when range P4, Iodine when range P5, Bromine when range P6, Iron LR when range P7 are selected. To change the active range follow the procedure:

- Turn the meter on by pressing **ON/OFF**. The display briefly shows all tags on.
- After startup, the range identification number is displayed on the secondary LCD as P1, P2, P3, P4, P5, P6 or P7.

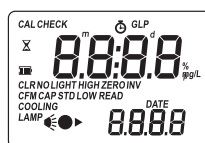

Code	Parameter
P1	pH
P2	Free Chlorine
P3	Total Chlorine
P4	Cyanuric Acid
P5	Iodine
P6	Bromine
P7	Iron LR

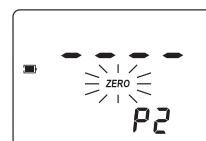
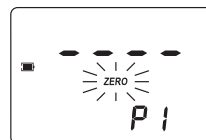

- Press **RANGE/GLP/▲** to change the range. The range can be changed any time when the instrument is in *measurement mode*.



The selected range is memorized and the selection remains unchanged at power off or when the battery is removed.

MEASUREMENT PROCEDURE

To compensate the meter for the sample turbidity or color, the measurement takes place in two phases. First, the meter is zeroed using the unreacted sample. After the reagents are added the reacted sample is measured.

Important note: Free and Total Chlorine have to be measured separately with fresh unreacted samples if both values are requested.

- Turn the meter on by pressing **ON/OFF**. The display briefly shows all tags on.

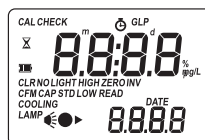

- When the beeper sounds briefly and the LCD displays dashes, the meter is ready. The blinking "ZERO" indicates that the instrument needs to be zeroed first.

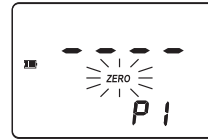

Note: Pay attention that the selected range is the one desired to run measurements. If not, change the range following the instructions from Range Selection.

pH MEASUREMENT

- Fill the cuvette with 10 mL of unreacted sample, up to the mark, and replace the cap.

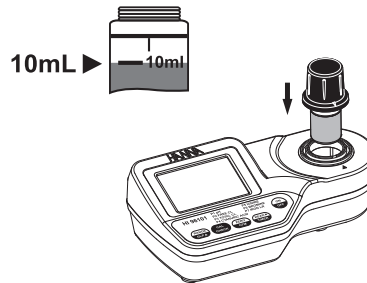

- Place the cuvette into the cuvette holder and ensure that the notch on the cap is positioned securely into the groove.

- Press ZERO/CFM and the lamp, cuvette and detector icons will appear on the display, depending on the measurement phase.

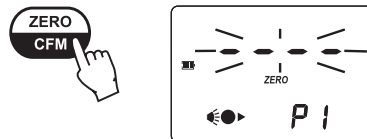

- After a few seconds, the display will show "-0.0-". The meter is now zeroed and ready for measurement.

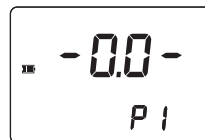

- Remove the cuvette and add 5 drops of the HI 93710-0 Phenol Red Indicator. Replace the cap and shake gently the solution.

- Replace the cuvette into the cuvette holder and ensure that the notch on the cap is positioned securely into the groove.

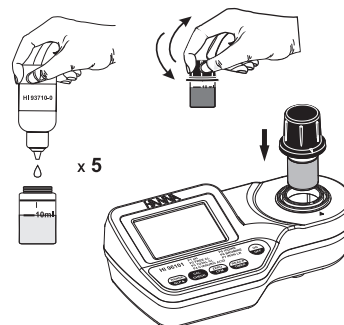

- Press **READ/▶/TIMER**. The lamp, cuvette and detector icons will appear on the display, depending on the measurement phase.
- The instrument directly displays the measured pH value on the Liquid Crystal Display.

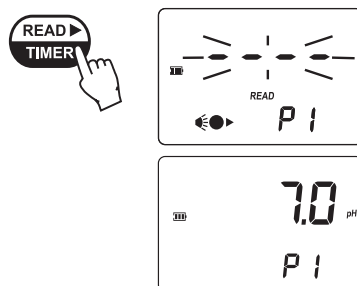

FREE CHLORINE MEASUREMENT

- Fill the cuvette up to the mark with 10 mL of unreacted sample and replace the cap.
- Place the cuvette into the holder and ensure that the notch on the cap is positioned securely into the groove.
- Press **ZERO/CFM** and the lamp, cuvette and detector icons will appear on the display, depending on the measurement phase.
- After a few seconds, the display will show **"-0.0-**". The meter is now zeroed and ready for measurement.

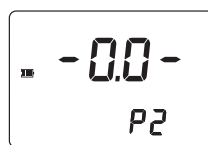
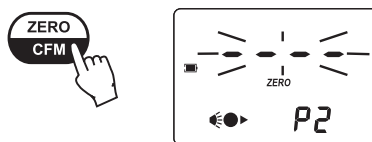
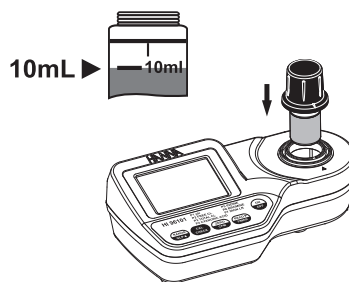

- Remove the cuvette.
- Add the content of one packet of **HI 93701-0** reagent. Replace the cap and shake gently for 20 seconds (or 2 minutes in case of seawater analysis).

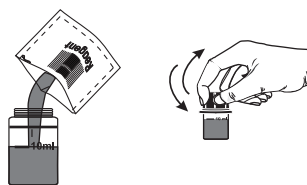

- Replace the cuvette into the cuvette holder and ensure that the notch on the cap is positioned securely into the groove.

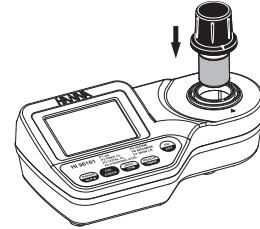

- Press and hold **READ/▶/TIMER** for three seconds. The display will show the countdown prior to measurement. An audible “beep” indicates the end of the countdown period.

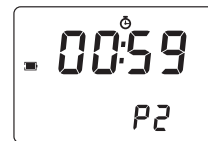

- Alternatively, wait for one minute and just press **READ/▶/TIMER**. In both cases, the lamp, cuvette and detector icons will appear on the display, depending on the measurement phase.

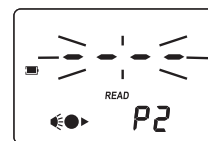

- The instrument directly displays concentration in mg/L of free chlorine on the Liquid Crystal Display.

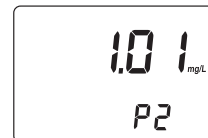

INTERFERENCES

Interference may be caused by:

Bromine

Iodine

Chlorine Dioxide

Ozone

Oxidized manganese and Chromium

In case of water with hardness greater than 500 mg/L CaCO₃, shake the sample for approximately 1 minute after adding the reagent.

In case of water with alkalinity greater than 250 mg/L CaCO₃ or acidity greater than 150 mg/L CaCO₃, the color of the sample could disappear or develop only partially. To resolve this, neutralize the sample with diluted HCl or NaOH.

TOTAL CHLORINE MEASUREMENT

- Fill the cuvette up to the mark with 10 mL of unreacted sample and replace the cap.
- Place the cuvette into the holder and ensure that the notch on the cap is positioned securely into the groove.
- Press **ZERO/CFM** and the lamp, cuvette and detector icons will appear on the display, depending on the measurement phase.
- After a few seconds, the display will show **"-0.0-"**. The meter is now zeroed and ready for measurement.
- Remove the cuvette and add one packet of **HI 93711-0** reagent. Replace the cap and shake gently for 20 seconds (or 2 minutes in case of seawater analysis).
- Replace the cuvette into the cuvette holder and ensure that the notch on the cap is positioned securely into the groove.
- Press and hold **READ/▶/TIMER** for three seconds. The display will show the countdown prior to measurement. An audible "beep" indicates the end of the countdown period.

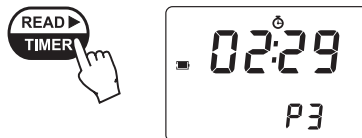
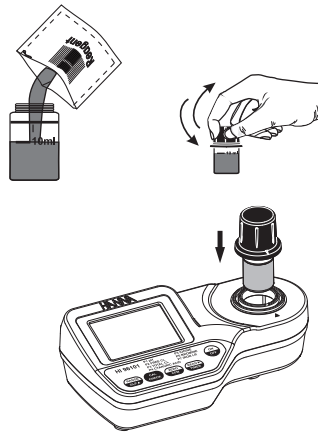
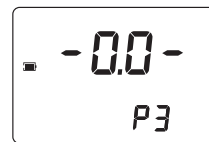
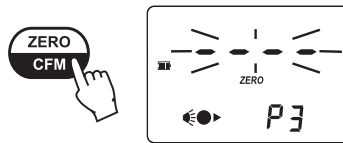
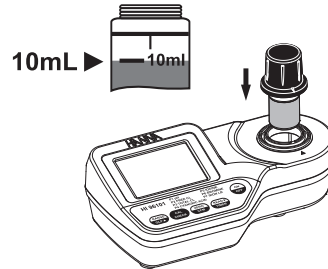

- Alternatively, wait for 2 minutes and 30 seconds and just press **READ/▶/TIMER**. In both cases, the lamp, cuvette and detector icons will appear on the display, depending on the measurement phase.

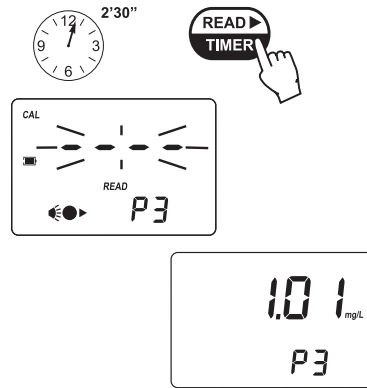

- The instrument directly displays concentration in mg/L of total chlorine on the Liquid Crystal Display.

INTERFERENCES

Interference may be caused by:

Bromine, Iodine, Chlorine Dioxide, Ozone, Oxidized manganese and Chromium.

In case of water with hardness greater than 500 mg/L CaCO_3 , shake the sample for approximately 1 minute after adding the reagent.

In case of water with alkalinity greater than 250 mg/L CaCO_3 or acidity greater than 150 mg/L CaCO_3 , the color of the sample could disappear or develop only partially. To resolve this, neutralize the sample with diluted HCl or NaOH.

CYANURIC ACID MEASUREMENT

- Fill the cuvette with 10 mL of unreacted sample, up to the mark, and replace the cap.
- Place the cuvette into the cuvette holder and ensure that the notch on the cap is positioned securely into the groove.
- Press **ZERO/CFM** and the lamp, cuvette and detector icons will appear on the display, depending on the measurement phase.
- After a few seconds, the display will show **"-0.0-"**. The meter is now zeroed and ready for measurement.

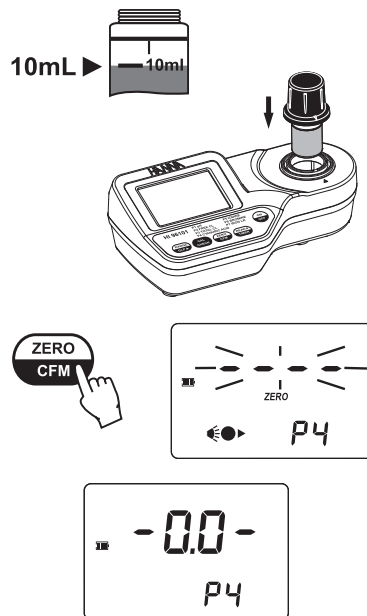

- Fill a beaker up to the 25 mL mark with the sample, add the content of one packet of HI 93722-0 reagent and swirl gently to mix. This is the reacted sample.



- Fill a second cuvette with 10 mL of the reacted sample, up to the mark, and replace the cap.



- Place the second cuvette into the cuvette holder and ensure that the notch on the cap is positioned securely into the groove.

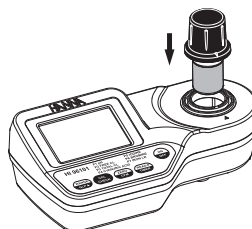

- Press and hold **READ/TIMER** for three seconds. The display will show the countdown prior to measurement. An audible “beep” indicates the end of the countdown period.

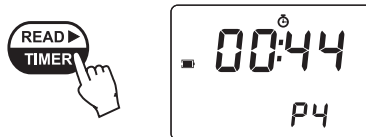

- Alternatively, wait for 45 seconds then just press **READ/TIMER**. In both cases, the lamp, cuvette and detector icons will appear on the display, depending on the measurement phase.

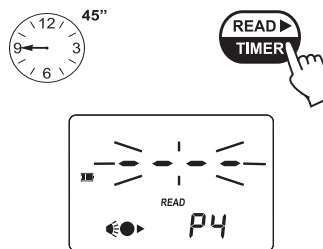

- At the end of measurement, the instrument directly displays concentration in mg/L of cyanuric acid on the LCD.

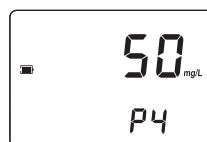

IODINE MEASUREMENT

- Fill the cuvette with 10 mL of unreacted sample, up to the mark, and replace the cap.
- Place the cuvette into the cuvette holder and ensure that the notch on the cap is positioned securely into the groove.
- Press **ZERO/CFM** and the lamp, cuvette and detector icons will appear on the display, depending on the measurement phase.

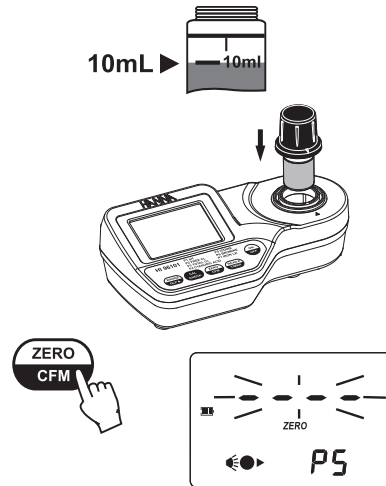

- After a few seconds, the display will show "-0.0-". The meter is now zeroed and ready for measurement.

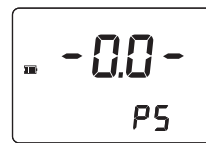

- Remove the cuvette.
- Add the content of one packet of **HI 93718-0** Iodine reagent. Replace the cap and shake gently for about 20 seconds to dissolve most of the reagent.

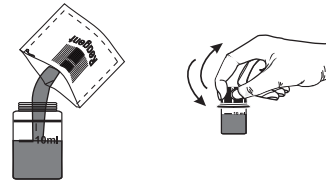

- Replace the cuvette into the cuvette holder and ensure that the notch on the cap is positioned securely into the groove.

- Press and hold **READ/▶/TIMER** for three seconds. The display will show the countdown prior to measurement. An audible "beep" indicates the end of the countdown period.

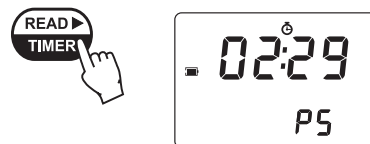

- Alternatively, wait for 2 minutes and 30 seconds then just press **READ/▶/TIMER**. In both cases, the lamp, cuvette and detector icons will appear on the display, depending on the measurement phase.
- At the end of measurement, the instrument directly displays concentration in mg/L of iodine on the LCD.

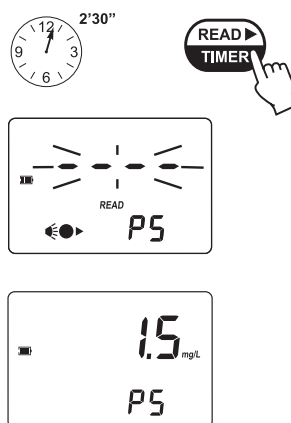

INTERFERENCES

Bromine

Chlorine

Ozone

Oxidized forms of chromium and manganese

In case of water with alkalinity greater than 250 mg/L CaCO_3 or acidity greater than 150 mg/L CaCO_3 , the color of the sample could disappear or develop only partially. To resolve this, neutralize the sample with diluted HCl or NaOH.

In case of water with hardness greater than 500 mg/L CaCO_3 , shake the sample for approximately 2 minutes after adding the reagent.

BROMINE MEASUREMENT

- Fill the cuvette with 10 mL of unreacted sample, up to the mark, and replace the cap.
- Place the cuvette into the cuvette holder and ensure that the notch on the cap is positioned securely into the groove.
- Press **ZERO/CFM** and the lamp, cuvette and detector icons will appear on the display, depending on the measurement phase.
- After a few seconds, the display will show **"-0.0-"**. The meter is now zeroed and ready for measurement.

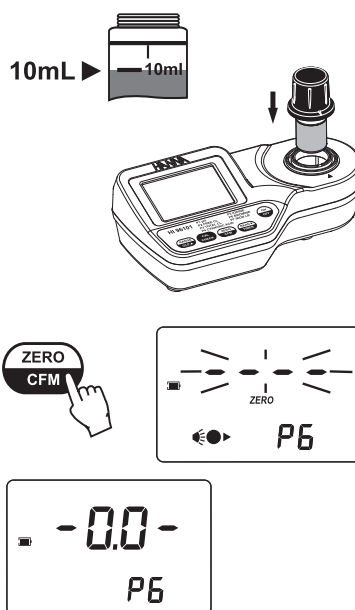

- Remove the cuvette.
- Add the content of one packet of **HI 93716-0** Bromine reagent. Replace the cap and shake gently for about 20 seconds to dissolve most of the reagent.
- Replace the cuvette into the cuvette holder and ensure that the notch on the cap is positioned securely into the groove.
- Press and hold **READ/▶/TIMER** for three seconds. The display will show the countdown prior to measurement. An audible “beep” indicates the end of the countdown period.
- Alternatively, wait for 2 minutes and 30 seconds then just press **READ/▶/TIMER**. In both cases, the lamp, cuvette and detector icons will appear on the display, depending on the measurement phase.
- At the end of measurement, the instrument directly displays concentration in mg/L of bromine on the LCD.

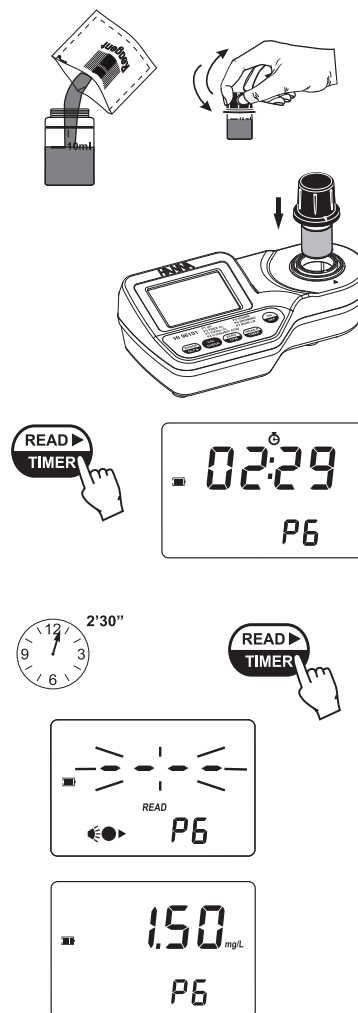

INTERFERENCES

Chlorine

Iodine

Ozone

Oxidized forms of chromium and manganese

In case of water with alkalinity greater than 250 mg/L CaCO_3 or acidity greater than 150 mg/L CaCO_3 , the color of the sample could disappear or develop only partially. To resolve this, neutralize the sample with diluted HCl or NaOH.

In case of water with hardness greater than 500 mg/L CaCO_3 , shake the sample for approximately 1 minute after adding the reagent.

IRON LR MEASUREMENT

- Fill one graduating mixing cylinder up to the 25 mL mark with deionized water.

- Add the content of one packet of HI 93746-0 TPTZ reagent, close the cylinder and shake vigorously for 30 seconds. This is the blank.

- Fill the cuvette with 10 mL of the blank up to the mark and replace the cap.

- Place the cuvette into the cuvette holder and ensure that the notch on the cap is positioned securely into the groove.

- Press **ZERO/CFM** and the lamp, cuvette and detector icons will appear on the display, depending on the measurement phase.

- After a few seconds, the display will show “-0.0-”. The meter is now zeroed and ready for measurement.

- Remove the cuvette.

- Fill another graduated mixing cylinder up to the 25 mL mark with the sample.

- Add the content of one packet of HI 93746-0 TPTZ reagent, close the cylinder and shake vigorously for 30 seconds. This is the reacted sample.

- Fill a cuvette with 10 mL of the reacted sample up to the mark and replace the cap.

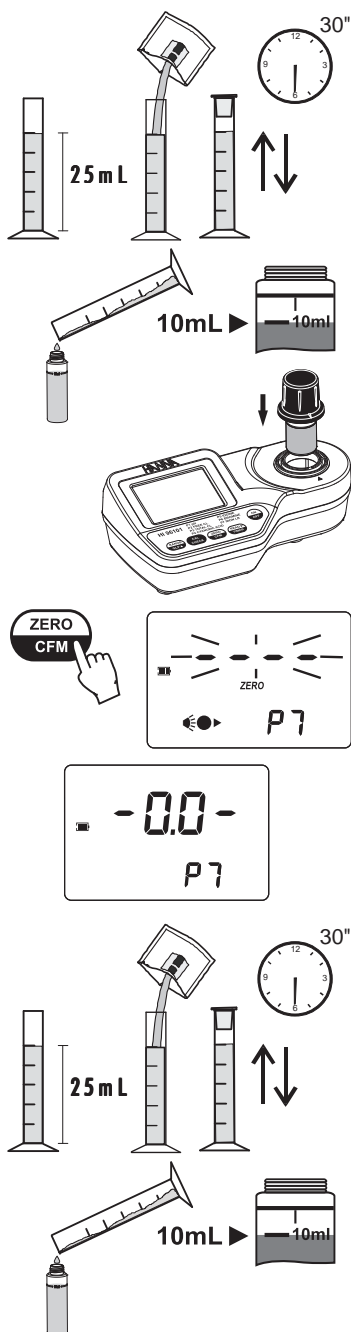

- Place the cuvette into the cuvette holder and ensure that the notch on the cap is positioned securely into the groove.

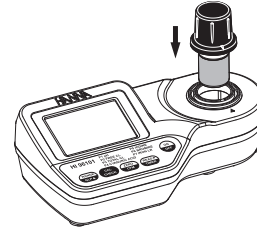

- Press and hold **READ/▶/TIMER** for three seconds. The display will show the countdown prior to measurement. An audible “beep” indicates the end of the countdown period.

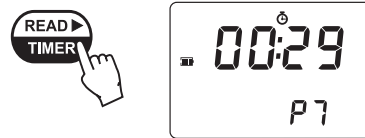

- Alternatively, wait for 30 seconds then just press **READ/▶/TIMER**. In both cases, the lamp, cuvette and detector icons will appear on the display, depending on the measurement phase.

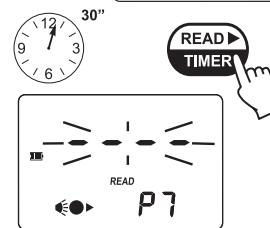

- At the end of measurement, the instrument directly displays concentration in mg/L of iron LR on the LCD.



INTERFERENCES

Interference may be caused by:

Cadmium above 4.0 mg/L; Chromium³⁺ above 0.25 mg/L; Chromium⁶⁺ above 1.2 mg/L; Cobalt above 0.05 mg/L; Copper above 0.6 mg/L; Cyanide above 2.8 mg/L; Manganese above 50.0 mg/L; Mercury above 0.4 mg/L; Molybdenum above 4.0 mg/L; Nickel above 1.0 mg/L; Nitrite ion above 0.8 mg/L.

Sample pH should be between 3 and 4 to avoid developed color to fade or turbidity formation.

VALIDATION PROCEDURE

Use the validation procedure to ensure that the instrument is properly calibrated.

Warning: Do not validate the instrument with any standard solutions other than the Hanna CAL CHECK™ Standards, otherwise erroneous results will be obtained.

Note: The validation is performed only for the selected parameter. For full validation of the instrument, the following procedure must be performed for each parameter.

- Turn the meter on by pressing **ON/OFF**.
- When the beeper sounds briefly and the LCD displays dashes, the meter is ready.
- Place the **CAL CHECK™** Standard Cuvette A into the cuvette holder and ensure that the notch on the cap is positioned securely into the groove.
- Press **ZERO/CFM** and the lamp, cuvette and detector icons will appear on the display, depending on the measurement phase.
- After a few seconds, the display will show “-0.0-”. The meter is now zeroed and ready for validation.
- Remove the cuvette.
- Place the corresponding **CAL CHECK™** Standard Cuvette B into the cuvette holder:
 - pH: B, HI 96710-11
 - Free Chlorine: B, HI 96701-11
 - Total Chlorine: B, HI 96711-11
 - Cyanuric Acid: B, HI 96722-11
 - Iodine: B, HI 96718-11
 - Bromine: B, HI 96716-11
 - Iron LR: B, HI 96746-11

Ensure that the notch on the cap is positioned securely into the groove.

- Press **CAL CHECK** and the lamp, cuvette and detector icons together with “CAL CHECK” will appear on the display, depending on the measurement phase.
- At the end of the measurement the display will show the validation standard value.

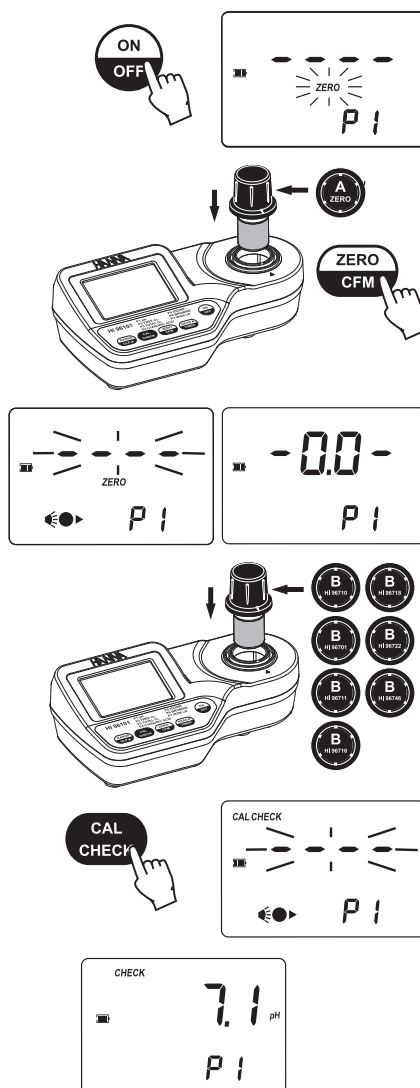

The reading should be within specifications as reported in the **CAL CHECK™** Standard Certificate. If the value is found out of the specifications, please check that the cuvettes are free of fingerprints, oil or dirt and repeat validation. If results are still found out of specifications, then recalibrate the instrument.

CALIBRATION PROCEDURE

Note: It is possible to interrupt calibration procedure at any time by pressing **CAL CHECK** or **ON/OFF** keys.

Warning: Do not calibrate the instrument with standard solutions other than the **HANNA CAL CHECK™** Standards, otherwise erroneous results will be obtained.

When calibrating, only the selected range is affected.

- Turn the meter on by pressing **ON/OFF**. When the beeper sounds briefly and the LCD displays dashes, the meter is ready.

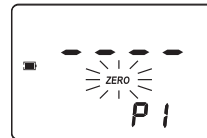

- Press and hold **CAL CHECK** for three seconds to enter *calibration mode*. The display will show "CAL" during calibration procedure. The blinking "ZERO" asks for instrument zeroing.

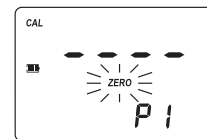

- Place the **CAL CHECK™** Standard Cuvette A into the cuvette holder and ensure that the notch on the cap is positioned securely into the groove.

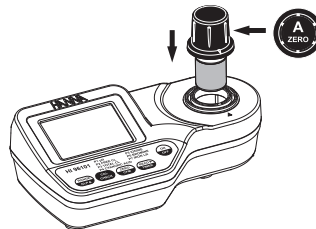

- Press **ZERO/CFM** and the lamp, cuvette and detector icons will appear on the display, depending on the measurement phase.

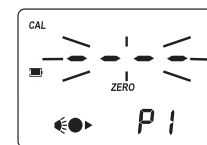

- After a few seconds the display will show "-0.0-". The meter is now zeroed and ready for calibration. The blinking "READ" asks for reading calibration standard.

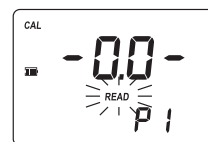

- Remove the cuvette.

- Place the corresponding **CAL CHECK™** Standard Cuvette B into the cuvette holder:

pH: B, HI 96710-11
 Free Chlorine: B, HI 96701-11
 Total Chlorine: B, HI 96711-11
 Cyanuric Acid: B, HI 96722-11
 Iodine: B, HI 96718-11
 Bromine: B, HI 96716-11
 Iron LR: B, HI 96746-11

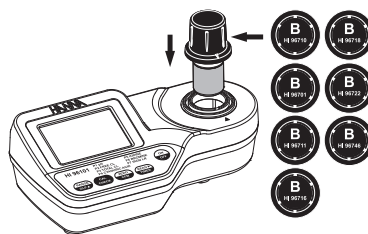

Ensure that the notch on the cap is positioned securely into the groove.

- Press **READ/▶/TIMER** and the lamp, cuvette and detector icons will appear on the display, depending on the measurement phase.
- After measurement the instrument will show for three seconds the **CAL CHECK™** Standard value.

Note: If the display shows “**STD HIGH**”, the standard value was too high. If the display shows “**STD LOW**”, the standard value was too low. Verify that all **CAL CHECK™** Standards Cuvettes, A and B are free from fingerprints or dirt and that they are inserted correctly.

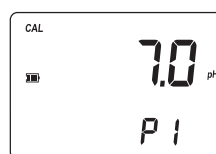
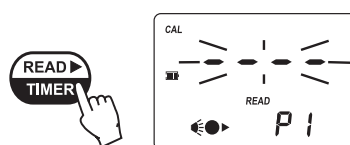

- Then the date of the last calibration (e.g.: “01.08.2009”) appears on the display, or “01.01.2009” if the factory calibration was selected before. In both cases the year number is blinking, ready for date input.

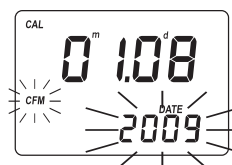

DATE INPUT

- Press **RANGE/GLP/▲** to edit the desired year (2009-2099). If the key is kept pressed, the year number is automatically increased.
- When the correct year has been set, press **ZERO/CFM** or **READ/▶/TIMER** to confirm. Now the display will show the month blinking.



OR



- Press **RANGE/GLP/▲** to edit the desired month (01-12). If the key is kept pressed, the month number is automatically increased.
- When the correct month has been set, press **ZERO/CFM** or **READ/▶/TIMER** to confirm. Now the display will show the day blinking.
- Press **RANGE/GLP/▲** to edit the desired day (01-31). If the key is kept pressed, the day number is automatically increased.

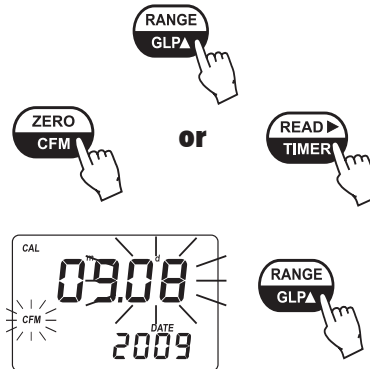
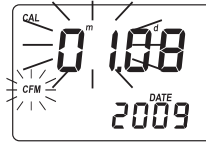

Note: It is possible to change the editing from day to year and to month by pressing **READ/▶/TIMER**.

- Press **ZERO/CFM** to save the calibration date.
- The instrument displays "**Stor**" for one second and the calibration is saved.
- The instrument will return automatically to *measurement mode* by displaying dashes on the LCD.

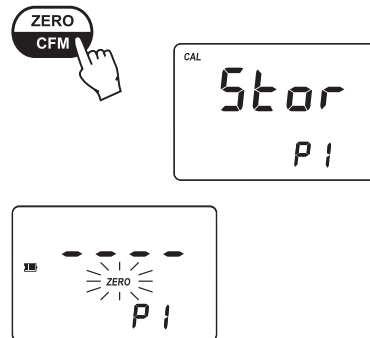

GLP

In the GLP mode, the last user calibration date can be verified and the factory calibration can be restored.

LAST CALIBRATION DATE

To display the calibration date:

- Press and hold for three seconds **RANGE/GLP/▲** to enter *GLP mode*. For the selected range the calibration month and day will appear on the main display and the year on the secondary display.

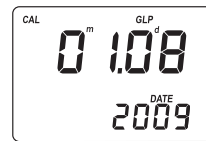

- If no calibration was performed, the factory calibration message, "F.CAL" will appear on the main display and the instrument returns to *measurement mode* after three seconds.



FACTORY CALIBRATION RESTORE

It is possible to delete the calibration and restore factory calibration.

- Press and hold for three seconds **RANGE/GLP/▲** to enter *GLP mode* for the selected range.
- Press **READ/▶/TIMER** to enter in the factory calibration restore screen. The instrument asks for confirmation of user calibration delete.
- Press **ZERO/CFM** to restore the factory calibration or press **RANGE/GLP/▲** again to abort factory calibration restore.
- The instrument briefly indicates "donE" upon restoration of factory calibration prior to returning to *measurement mode*.

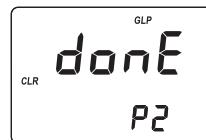
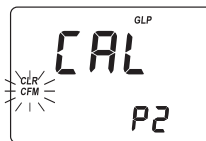

BATTERY MANAGEMENT

To save battery, the instrument shuts down after 10 minutes of non-use in *measurement mode* and after 1 hour of non-use in *calibration mode*.

If a valid measurement was displayed before auto-shut off, the value is displayed when the instrument is switched on. The blinking "ZERO" means that a new zero has to be performed.

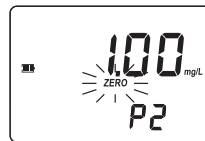

One fresh battery lasts for around 750 measurements, depending on the light level.

The remaining battery capacity is evaluated at the instrument startup and after each measurement.

The instrument displays a battery indicator with three levels as follows:

- 3 lines for 100 % capacity
- 2 lines for 66 % capacity
- 1 line for 33 % capacity
- Battery icon blinking if the capacity is under 10 %.

If the battery is empty and accurate measurements can't be taken anymore, the instrument shows "dEAd bAtt" and turns off.

To restart the instrument, the battery must be replaced with a fresh one.

BATTERY REPLACEMENT

To replace the instrument's battery, follow the steps:

- Turn the instrument off by pressing ON/OFF.
- Turn the instrument upside down and remove the battery cover by turning it counterclockwise.

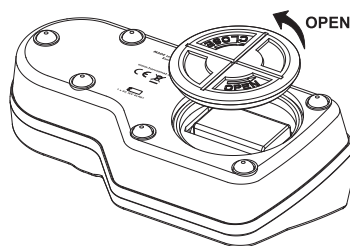

- Extract the battery from its location and replace it with a fresh one.
- Insert back the battery cover and turn it clockwise to close.

ACCESORIES

REAGENT SET

HI 93701-01	Reagents for 100 free chlorine tests
HI 93701-03	Reagents for 300 free chlorine tests
HI 93710-01	Reagents for 100 pH tests
HI 93710-03	Reagents for 300 pH tests
HI 93711-01	Reagents for 100 total chlorine tests
HI 93711-03	Reagents for 300 total chlorine tests
HI 93716-01	Reagents for 100 bromine tests
HI 93716-03	Reagents for 300 bromine tests
HI 93718-01	Reagents for 100 iodine tests
HI 93718-03	Reagents for 300 iodine tests
HI 93722-01	Reagents for 100 cyanuric acid tests
HI 93722-03	Reagents for 300 cyanuric acid tests
HI 93746-01	Reagents for 50 iron low range tests
HI 93746-03	Reagents for 100 iron low range tests

OTHER ACCESORIES

HI 96701-11	CAL CHECK™ Standard Cuvettes for Free Chlorine (1 set)
HI 96710-11	CAL CHECK™ Standard Cuvettes for pH (1 set)
HI 96711-11	CAL CHECK™ Standard Cuvettes for Total Chlorine (1 set)
HI 96716-11	CAL CHECK™ Standard Cuvettes for Bromine (1 set)
HI 96718-11	CAL CHECK™ Standard Cuvettes for Iodine (1 set)
HI 96722-11	CAL CHECK™ Standard Cuvettes for Cyanuric Acid (1 set)
HI 96746-11	CAL CHECK™ Standard Cuvettes for Iron (1 set)
HI 721310	9V battery (10 pcs.)
HI 731318	Tissue for wiping cuvettes (4 pcs.)
HI 731331	Glass cuvettes (4 pcs.)
HI 731335	Caps for cuvettes (4 pcs.)
HI 93703-50	Cuvettes cleaning solution (230 mL)

WARRANTY

HI 96101 is warranted for two years against defects in workmanship and materials when used for its intended purpose and maintained according to the instructions.

This warranty is limited to repair or replacement free of charge.

Damages due to accident, misuse, tampering or lack of prescribed maintenance are not covered. If service is required, contact your dealer. If under warranty, report the model number, date of purchase, serial number and the nature of the failure. If the repair is not covered by the warranty, you will be notified of the charges incurred.

If the instrument is to be returned to Hanna Instruments, first obtain a Returned Goods Authorization Number from the Customer Service Department and then send it with shipment costs prepaid. When shipping any instrument, make sure it is properly packaged for complete protection.

To validate your warranty, fill out and return the enclosed warranty card within 14 days from the date of purchase.

Recommendations for Users

Before using these products, make sure that they are entirely suitable for your specific application and for the environment in which they are used.

Operation of these instruments may cause unacceptable interferences to other electronic equipments, this requiring the operator to take all necessary steps to correct interferences.

Any variation introduced by the user to the supplied equipment may degrade the instruments' EMC performance.

To avoid damages or burns, do not put the instrument in microwave oven. For yours and the instrument safety do not use or store the instrument in hazardous environments.

Hanna Instruments reserves the right to modify the design, construction and appearance of its products without advance notice.



Hanna Instruments Inc.
Highland Industrial Park
584 Park East Drive
Woonsocket, RI 02895 USA

Technical Support for Customers
Tel. (800) 426 6287
Fax (401) 765 7575
E-mail tech@hannainst.com
www.hannainst.com

Local Sales and Customer Service Office

